

CONTROL TECHNIQUES



NE200 & NE300

HIGH PERFORMANCE VECTOR CONTROL DRIVE

220/380VAC 0.4~900KW 0~550HZ

DRIVE OBSESSED

NE200 & NE300

FEATURES &

ACCESSORIES

Outstanding control performance

- Outstanding software control platform with unique vector control algorithm
- Renesas 32 bit high speed motor control DSP
- Authentic current vector control: torque current and field current decoupling control
- Advanced vector control algorithm: induction motor and PM motor control
- Three control modes: Vector control without PG, Vector control with PG and V/F control
- The real hardware speed tracking function, more stable and reliable than the software tracking function
- Dynamic current torque control, quickly response to load variation
- Accelerating current suppression, unique current algorithm avoid machine trip due to high startup current without impacting startup torque
- Superior torque performance at low frequency, open loop vector control 150% torque output at 0.5Hz, satisfied low frequency high torque applications such as machine tool, crane and hoist industry.
- Superior overload performance: 180% current for 20s
- High precision speed control, enable high accurate synchronous control

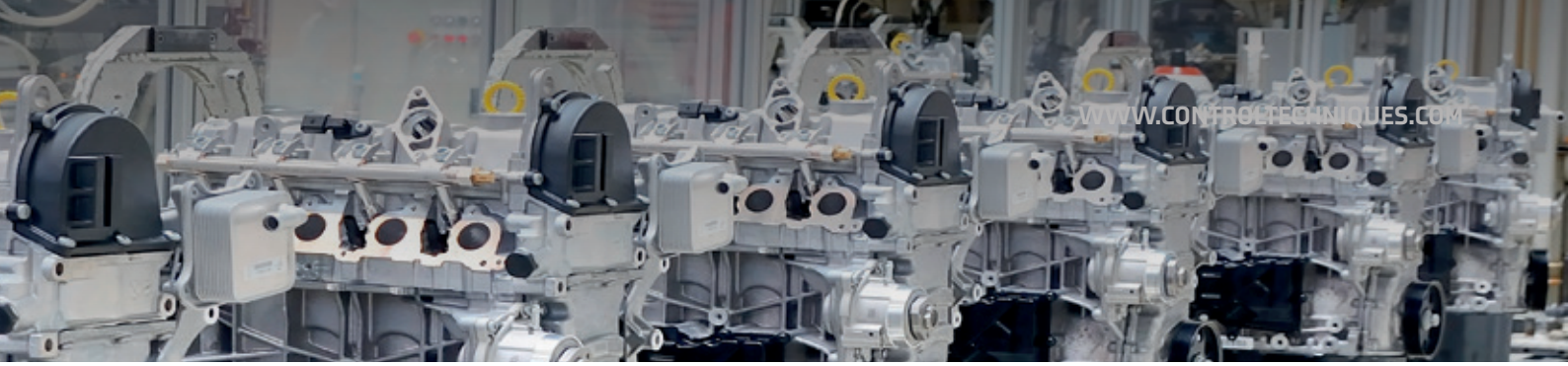

Powerful function

- Multiple frequency setup function
- Open-loop / close-loop torque control function, torque control mode/ speed control mode online switching
- PID function provide two groups PI parameters, PID output range is settable, supporting sleep mode
- V/F separate control function in V/F control mode
- Tension control drive enable automatic rolling diameter calculation pre-setup function
- Automatic load balance droop control function
- Fixed length control function
- RS-485 communication port supporting MODBUS-RTU communication protocol for multi drive synchronization.
- Various extension cards are optional for flexible applications.
- Automatic energy saving function, power off automatically restart function, and parameter cloning through keypad.
- Parameter backup function and recovery through terminals.
- Rich protection and supervision functions.

Novel design

- Independent ventilation design for all whole series products, ventilation channel and electrical components are separated, reduce the failure rates for electrical parts.
- Compact design, based on thermal simulation and design to reduce product size, the size of products is around 70% of main stream brands at the same power rating.
- Graphic keypad to satisfy majority operation behavior
- Control panel standard RJ45 port, enhanced communication anti-interference ability, convenient to extension.
- Aluminum zinc plate and painting protection ensure the grounding protection, shielding performance and products' rot resistance.
- DC fan design for whole series products, reduce cooling system failure rate leading by AC fan breakdown

Superior adaptability

- Unique IGBT drive circuit, more reliable operation for power components
- Phase-to-phase Short-circuit protection for all product, grounding protection for >18.5KW products, adaptable for harsh environment
- Wide working voltage range: 304VAC~456VAC
- German conformal coating material
- Optimize EMC design, immunity for high interference environment
- 100% incoming inspection
- Automatic PCB and drive tests
- High temperature aging test for PCB and drives.



*Please consult our company for customized drive model detail.



NE200 & NE300

Solution of Direct feed Wire Drawing Machine

Solution advantages

- Feedforward PID control mode can be adopted between processes of the system. The main speed is calculated from the metal flow per second from the previous process. As a fine adjustment of the system speed, the speed calculation is made inside the variable-frequency drive, improving response time and simplifying the commission work.
- Users can choose between speed mode and torque mode for the winding part based on their requirements. The speed mode adopts PID feedforward control method, which requires a tension frame. The torque mode does not need a tension frame, and the winding machine follows the speed of the main machine by maintaining the constant tension of the wire rod;
- The variable-frequency drive is equipped with built-in winding diameter calculation function, which can quickly and accurately calculate the winding diameter to ensure that the rotation speed of the take-up motor meets the requirements of constant linear speed winding of materials;
- Motor speed command can be realized through analog quantity, pulse quantity ModBus communication and other methods according to user requirements, and the logic controls to coordinate the different parts within a system are realized by PLC.

Solution features

- The current vector variable-frequency driver ensures that the system has excellent low frequency performance and dynamic performance;
- With excellent built-in PID or torque mode, the system has good dynamic performance, and the system is made simple.

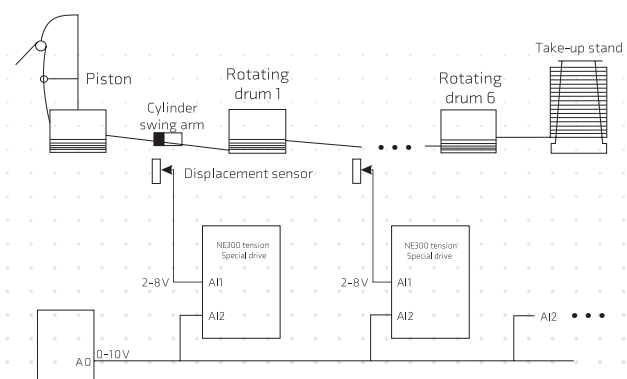



NE200 & NE300

Solution of Wire Drawing Machine with double VFDs

Solution advantages

- User can choose between speed mode and torque mode according to their requirements. For speed mode, PID feedforward method is adopted, which requires a tension frame. The torque mode does not need a tension frame, and the winding machine follows the speed of the main machine by keeping the constant tension of the wire;
- The variable-frequency drive is equipped with built-in winding diameter calculation function, which can quickly and accurately calculate the winding diameter to ensure that the rotation speed of the take-up motor meets the requirements of constant linear speed winding of materials;
- Automatic detection of material fracture: It can automatically identify the state of material fracture and raise an alarm without an additional detection device.

Solution features

- The variable-frequency drive can completely realize the main electrical control of the wire drawing machine without additional controller and, therefore, the system structure is simplified;
- During operation, the fluctuation of the swing rod is small. When the machine starts after shutdown, the rod will be positions automatically without any human actions;
- It runs smoothly in the whole working range of linear speed command, and the driving motor can quickly respond to the sudden change of linear speed command;
- The standard operation panels of the two variable-frequency drives can be relocated outside of the process cells by using extension cables. And they can be used as displays for linear speedometers and meter counters.

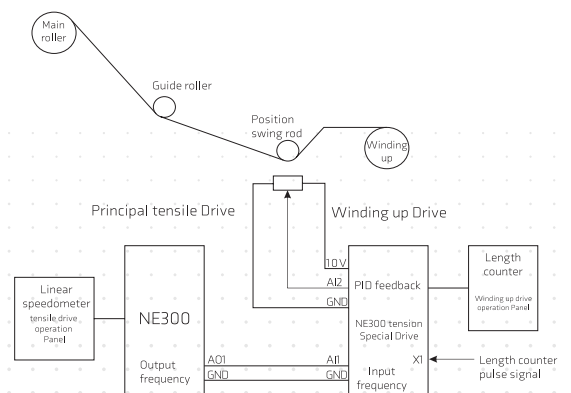

Application of Constant Tension Control System

Solution features

- High performance vector control / torque control technology realizes constant linear speed and constant tension control;
- Tension feedback solution: the winding machine outputs the most matching torque according to tension setting, tension feedback signal and current winding diameter. As a result, constant tension control of the system is realized;
- Tension-free feedback solution: the winding machine automatically follows the speed of the main machine and obtains ideal torque output according to the tension setting and the current winding diameter. As a result, constant tension control is achieved;
- Applicable to the following equipment: slitting machine, coating machine, paper machine, printing machine, compound machine, jig dyeing machine, etc.

Solution advantages

- Stable control: the closed-loop tension control mode of NE300 tension special variable-frequency drive can provide tension stability in the process of acceleration and deceleration of the system;
- Integrated winding diameter calculation function and tension control compensation algorithm, simplifying PLC program development and making it effective and convenient;
- Double-station winding: With the equipped pre-drive function, winding reel can be switched over automatically and quickly without shutting down the line, improving production efficiency;
- The taper of winding can be controlled conveniently and accurately to avoid bad "flowering cabbage" shape and improve the winding quality;
- A variety of additional practical functions, such as: fracture detection and alarm, fracture overrun protector, length counter, linear speedometer, etc.

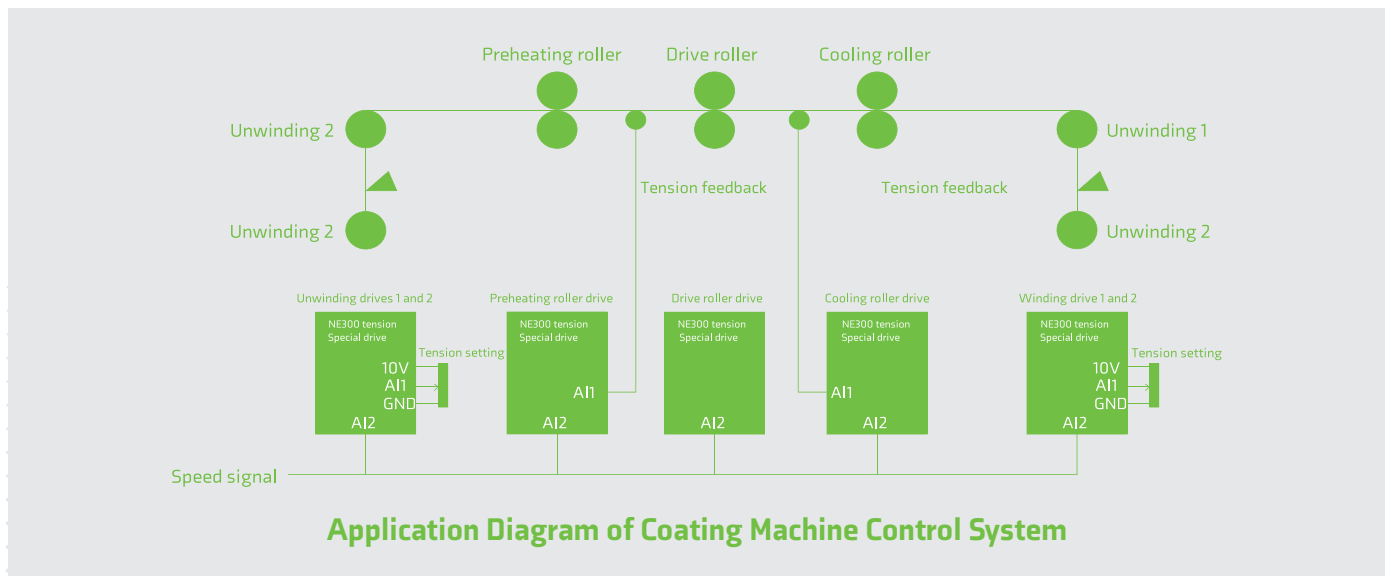

Compressor industry solution

Solution features

- High performance speed sensor-less vector control technology. High efficiency low energy consuming, energy saving rate can reach max. 50%. Special integrated design to adapt with air compressor operation characteristics, completely change the traditional mode of general purpose drive + special controller
- Vector control speed stabilization precision is 0.2%, quickly and accurately response to pressure variation, close-loop constant air supply precision can reach $\pm 0.01\text{MPa}$;
- High startup torque can fully support compressor fully loading starting up.
- Superior overload capacity, wider speed control range, can fully satisfied air system temporary overload requirement
- Superior software and hardware protection ensures compressor system reliability and stability.
- Steady starting and operating, no impact for power grid, low wear, long life, and low noise.



Solution advantages

- Constant pressure control: Inbuilt high efficiency PID algorithm, quick response to air demand;
- Frequency conversion/power frequency switching: ensure non-stopping air supply;
- Intelligent system: Timing control, Automatic sleep, Automatic wake-up and other functions
- Cascade control: multiple air compressors supply gas at the same time, automatic allocation of working hours and output power
- User interface: optional text display keypad and touch screen graphic screen.

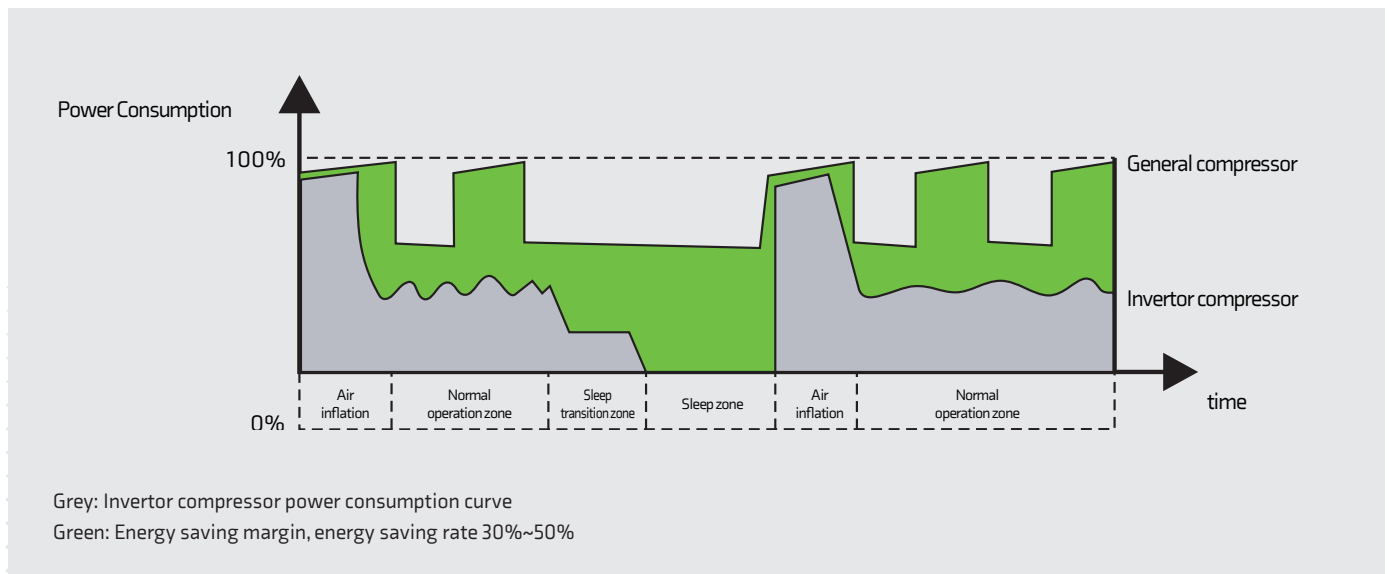

Machine tool industry solution

Solution features

- Variable V/F and vector control modes are applicable for various machine tools, e.g.: lathe, miller, driller, grinder, and carving machine, etc.;
- Unique digital signal tiny pulse harmonic control technology ensures super quiet operation;
- Variable speed command channels: current/ voltage analog input, pulse input, communication input.



Solution advantages

- High torque at low frequency: Reduce 90% during cutting compared with open-loop control, satisfied machine tools' principle axis low speed heavy cutting requirement;
- High speed stabilization precision: speed stabilization precision is 0.02% of rated speed, speed fluctuation is small;
- Reliable operation control: inbuilt torque limitation and over voltage protection avoid trip;
- Quick dynamic response: dynamic torque response time <math>< 20\text{ms}</math>, small speed fluctuation during instant upload or unload;
- Superior overload capacity: 150% rated current 1min, 200% rated current 0.5s.

Solution for Application of Industrial Washing Machine

Solution features

- The application has strong adaptability for the input voltage and can also be used under the condition of instantaneous fluctuation of 20% rated voltage;
- The size is equivalent to 70% of that of other VFD with the same power, which facilitates the installation;
- The thickened cover enhanced by triple-protection treatment process and optional dust-proof cover plates make the products more reliable in harsh environment;
- The migration functions of parameters are supported by the operation panels, significantly simplifying the commission and maintenance work.



Solution advantages

- Low frequency and large torque: It can output 0.50Hz 180% rated torque, suitable for start-up with load;
- Reliable operation control: built-in torque limit and undervoltage and overvoltage regulation;
- Perfect four-quadrant control technology supports forward and reverse rotation and fast acceleration and deceleration, supporting the frequent forward and reverse rotation direction changes during washing;
- The voltage and current regulation technology under the constant power of the motor enables the motor to work stably at high frequency, which is suitable for high-speed dehydration.

Torque motor substitution solution

Solution features

- Significant energy saving effect and reliable operation, without extra heat loss, extend system working life;
- No requirement for extra encoder, saving cost and completely immune external interference;
- Retrofit system will not change original operation behavior;
- Steady torque output, reliable operation.



Solution advantages

- Superior overload capacity: 150% rated current 1min, 200% rated current 0.5s;
- High torque at low frequency: 180% rated torque at 0.5Hz;
- Reliable operation control: inbuilt torque limitation and overvoltage adjustment, avoid trip;
- Quick dynamic response: dynamic torque response time < 20ms, small speed fluctuation during instant upload or unload;
- Synchronized winding: high performance open-loop vector control, ensure post stage winding speed follows the forestage winding at any time.
- Full lap start/stop: drive startup torque high and stable even under full lap condition with highest inertia, automatic torque output compensation according to roll diameter variation;
- Whole speed range operation: winding motor can stably operate at extra low speed (0.5Hz) and relatively high speed, even in motor constant power zone.

NE200 series drive technical specifications:

Input	Rated power/ frequency	NE200-2Sxxxx: 1-phase 200V ~ 240V; 50Hz/60Hz NE200-4Txxxx: 3-phase 380V ~ 440V; 50Hz/60Hz		
	Voltage range	NE200-2Sxxxx: 176V ~ 264V; Voltage unbalance degree: ≤ 3% ; permissible frequency fluctuation: ±5% NE200-4Txxxx: 304V ~ 456V; Voltage unbalance degree: ≤ 3% ; permissible frequency fluctuation: ±5%		
Output	Voltage range	NE200-2Sxxxx: 0~200V/440V; NE200-4Txxxx: 0~380V/440V		
	Overload capacity	Type G: 150% rated current 1min, 180% rated current 20s Type P: 120% rated current 1min, 150% rated current 1s		
Control features	Control mode	Vector control with PG (VC)	Vector control without PG (SVC)	V/F control
	Startup torque	---	0.5Hz 150%	1.5Hz 150%
	Speed adjustable range	---	1:100	1:50
	Speed Precision	---	± 0.2%	± 0.5%
	Torque control	---	Yes	N/A
	Torque precision	---	± 10%	---
	Torque response time	---	<20ms	---
Product functions	Key functions	Torque/speed control mode switching, Multi-function input/ output terminals, under voltage regulation, AC operation grounding switching, torque limit, multi step operation, slip compensation, PID regulation, simple PLC, current control, manual/ automatic torque boost, current limit, AVR function		
	Frequency setup	Keypad, terminal Up/Down, Communication, Analog input AI1/AI2		
	Output frequency	0.00~550.0Hz		
	Startup frequency	0.00~60.00Hz		
	Acc/Dec time	0.01~3600.0s		
	Dynamic braking	400V drive: braking unit action voltage: 650 ~ 750V; 200V drive: braking unit action voltage: 360 ~ 390V;		
	DC injection braking	DC braking activation frequency: 0.00 ~ 550.0Hz		
		DC braking current: G type 0.0 ~ 100.0%; P type 0.0 ~ 80.0% DC braking time: 0.0 ~ 30.0s; Quick DC brake activation without lag time		
Magnetic flux braking	Fast deceleration through adding motor magnetic flux			
Unique functions	Parameter cloning	Parameter upload, download. User can forbid the overwriting of the uploaded parameters.		
Protection function	Power undervoltage/overvoltage protection, overcurrent protection, IGBT protection, heatsink overheat protection, drive overload protection, motor overload protection, External devices faults protection, output phase-to-phase short-circuit protection, Abnormal power failure in running, power supply trip, output phase loss, EEPROM trip, Analog input trip, communication trip, version compatibility trip, cloning trip, hardware overload protection			
Environment	Application environment	Vertical installation in well ventilated cabinet. Horizontal or other installation are forbidden. The cooling medium is air. Free from direct sunlight, dust, corrosive gas, combustible gas, oil mist, steam, and water drop.		
	Ambient temperature	-10~+40°C, deration is required from 40 to 50°C, rated output current decreasing 1% per 1°C temperature higher		
	Humidity	5~95% without condensation		
	Altitude	0~2000m, deration is required for more than 1000 meters, at rated output current decreasing 1% per 100m higher		
	Vibration	3.5mm, 2~9Hz; 10 m/s ² , 9~200Hz; 15 m/s ² , 200~500Hz		
Structure	Storage temperature	-40~+70°C		
	Protection level	IP20		
	Cooling	Fan air cooling		

NE200 TERMINAL DIAGRAM

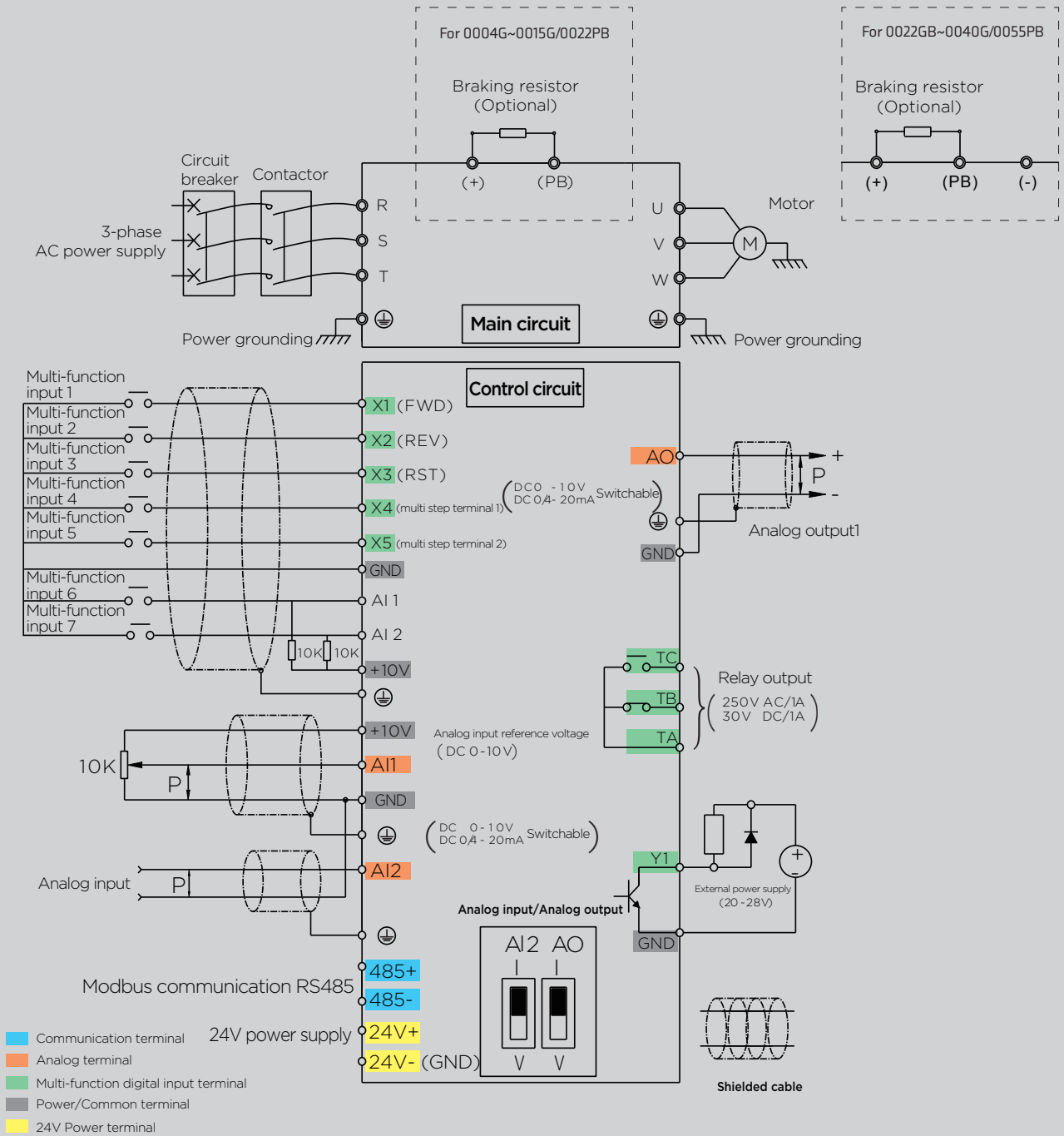



Main circuit input / output terminals

NE200 have two types of main circuit terminals, please check your drive model with tables below :

1. NE200-2S0004GB, NE200-2S0007GB, NE200-2S0015GB, NE200-4T0007G/0015PB,
NE200-4T0015G/0022PB

	R	S	T	(+)	PB	U	V	W	

Terminal symbol	Terminal type and description
	Grounding terminal PE
R,S	1- phase AC input terminals
R,S,T	3-phase AC input terminals
(+),PB	Terminals reserved for braking resistor
U,V,W	3-phase AC output terminals

2. NE200-2S0022GB, NE200-4T0022G/0040PB, NE200-4T0040G/0055PB

	R	S	T	(-)	(+)	PB	U	V	W

Terminal symbol	Terminal type and description
	Grounding terminal PE
R,S	1- phase AC input terminals
R,S,T	3-phase AC input terminals
(+),(-)	DC bus negative and positive terminals for common DC bus input
(+),PB	Terminals reserved for braking resistor
U,V,W	3-phase AC output terminals

NE300 series drive technical specifications:

Input	Rated power/ frequency	3-phase 380V ~ 440V; 50Hz/60Hz		
	Voltage range	304V ~ 456V; Voltage unbalance degree: $\leq 3\%$; Permissible frequency fluctuation: $\pm 5\%$		
Output	Voltage range	0~380V/440V		
	Overload capacity	Type G: 150% rated current 1min, 180% rated current 20s Type P: 120% rated current for 1min, 150% rated current for 1s		
Control features	Control mode	Vector control with PG(VC)	Vector control without PG(SVC)	V/F control
	Startup torque	0.00Hz 180%	0.5Hz 150%	1.5Hz 150%
	Speed adjust range	1:1000	1:100	1:50
	Speed stabilization precision	$\pm 0.02\%$	$\pm 0.2\%$	$\pm 0.5\%$
	Torque control	Yes	Yes	N/A
	Torque precision	$\pm 5\%$	$\pm 10\%$	---
	Torque response time	<10ms	<20ms	---
	Product functions	Key functions	Torque/speed control switching, Multi-function input/ output terminals, under voltage regulation, AC operation grounding switching, flying start, torque limit, multi speed operation, autotune, S curve Acc/Dec, slip compensation, PID regulation, simple PLC, fix length control, droop control, current control, manual/ automatic torque increase, current limit, AVR function	
Frequency setup		Keypad, terminal Up/Down, communication, Analog input AI1/AI2, Terminal pulse input X4,X5		
Output frequency		0.00~550.0Hz		
Startup frequency		0.00~60.00Hz		
Acc/Dec time		0.1~3600s		
Dynamic braking		400V drive: braking unit voltage: 650 ~ 750V; 200V drive: braking unit voltage: 360 ~ 390V;		
DC injection braking		DC braking activation: 0.00 ~ 550.0Hz DC braking current: G type 0.0 ~ 100.0%; P type 0.0 ~ 80.0% DC braking time: 0.0 ~ 30.0s; Quick DC brake activation without lag time		
Magnetic flux braking		Fast deceleration through adding motor magnetic flux		
Unique functions	Parameter cloning	Parameter upload, download. User can forbid the overwriting of the uploaded parameters.		
	Keypad	LED keypad as standard.		
	Common DC bus	Common DC bus for multiple drives power supply		
	Independent air duct	Independent air duct design for whole series product		
	Extension card	IO extension card, injection molding machine connecting card etc.		
Protection function	Power-up detection Automatic detection of internal and external circuits when power-up			
Efficiency	Power undervoltage/overvoltage protection, overcurrent protection, autotune trip, IGBT protection, heatsink overheat protection, drive overload protection, motor overload protection, external device false protection, output to ground short-circuit protection, abnormal power failure in running, power supply abnormal, output phase loss, EEPROM trip, relay contact error, temperature sampling abnormal, encoder off-line, analog input trip, communication trip, version compatibility trip, cloning trip, extension card connection trip, hardware overload protection			
Environment	Application environment	Operation at rated power: 7.5kW or below $\geq 93\%$; 11kW~45kW $\geq 95\%$; 55kW or above $\geq 98\%$		
	Ambient temperature	Vertical installation in well ventilated cabinet. Horizontal or other installation are forbidden. The cooling medium is air. Free from direct sunlight, dust, corrosive gas, combustible gas, oil mist, steam, and water drop.		
	Humidity	-10°C~+40°C, deration is required from 40 to 50°C, rated output current decreasing 1% per 1°C temperature higher		
	Altitude	5~95% without condensation		
	Vibration	0~2000m, deration is required for more than 1000 meters, at rated output current decreasing 1% per 100m higher		
Structure	Storage temperature	3.5mm, 2~9Hz; 10 m/s ² , 9~200Hz; 15 m/s ² , 200~500Hz		
	Protection level	-40~+70°C		
	Cooling	IP20		
		Fan force cooling		

*Please consult our company for vector control drive with PG model selection.

NE300 TERMINAL DIAGRAM

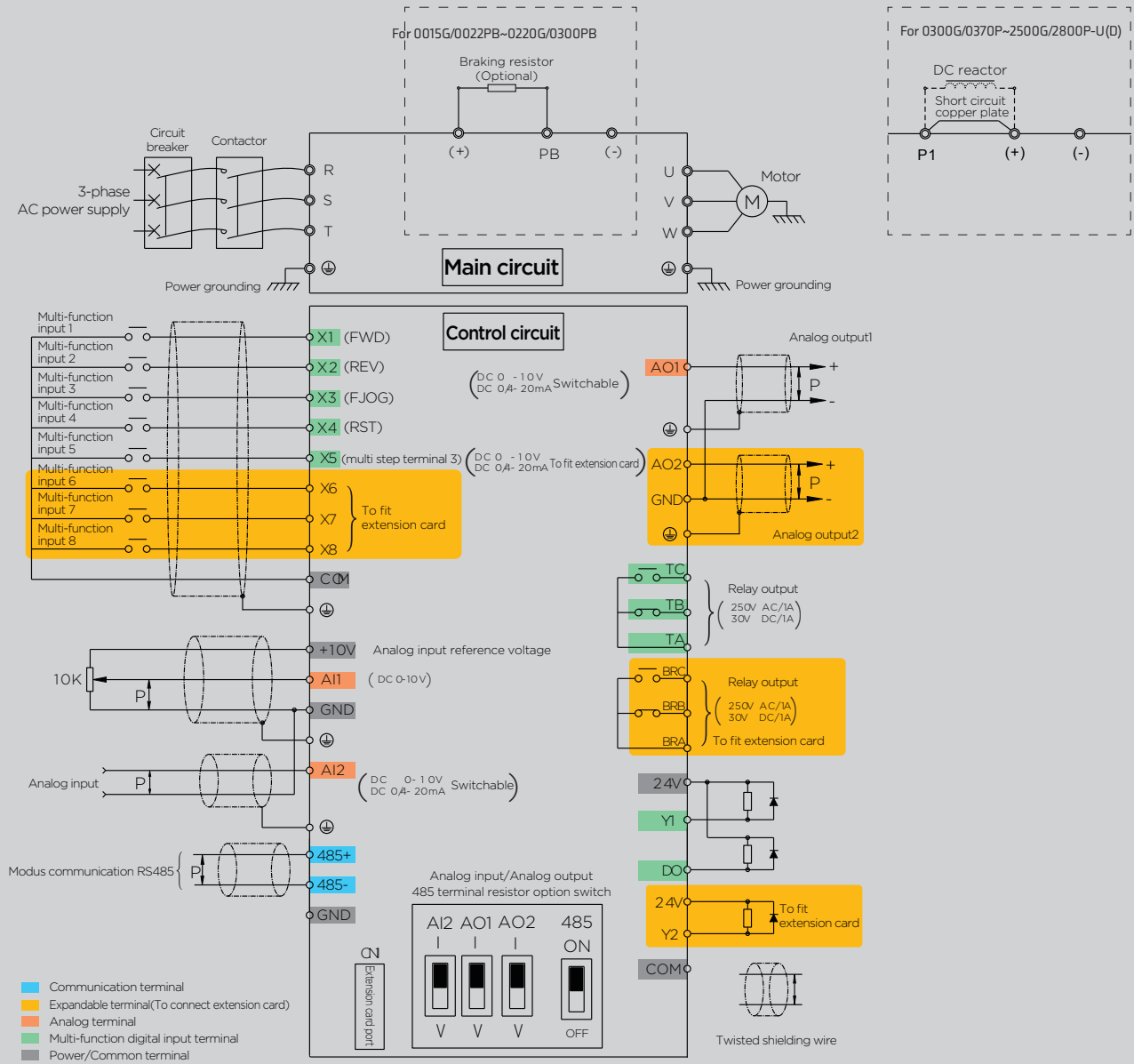

Terminal connection

Note 1: NE300-4T0015G/0022PB ~ NE300-4T0220G/0300PB equip braking unit

Note 2: NE300-4T1600G/1850P-F ~ NE300-4T9000G-F equip DC reactor

Main circuit input / output terminals

NE300 have five types of main circuit terminals, check your drive model with tables below :

1, NE300-4T0015G/0022PB ~ NE300-4T0220G/0300PB

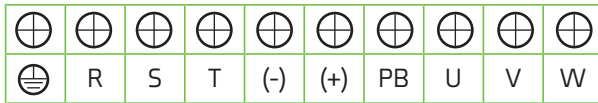

Terminal symbol	Terminal type and description
	Grounding terminal PE
R, S, T	3-phase AC input terminals
(-), (+)	DC bus negative and positive terminals for common DC bus input
(+), PB	Terminals reserved for braking resistor
U, V, W	3-phase AC output terminal

2, NE300-4T0300G/0370P ~ NE300-4T1100G/1320P

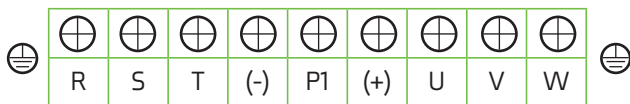

Terminal symbol	Terminal type and description
	Grounding terminal PE
R, S, T	3-phase AC input terminals
(-), (+)	DC bus negative and positive terminals for common DC bus input
P1, (+)	Reserved for DC reactor connecting terminals; Short circuited with copper plate as factory setting
U, V, W	3-phase AC output terminals

3, NE300-4T1320G/1600PB-U ~ NE300-4T2500G/2800PB-U

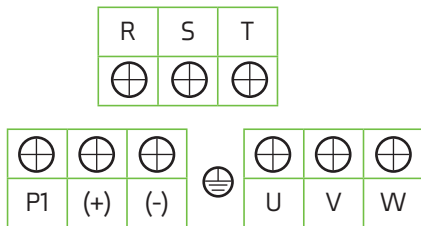

Terminal symbol	Terminal type and description
	Grounding terminal PE
R, S, T	3-phase AC input terminals
(-), (+)	DC bus negative and positive terminals for common DC bus input
P1, (+)	Reserved for DC reactor connecting terminals; Short circuited with copper plate as factory setting
U, V, W	3-phase AC output terminals

4, NE300-4T1320G/1600PB-D ~ NE300-4T2500G/2800PB-D

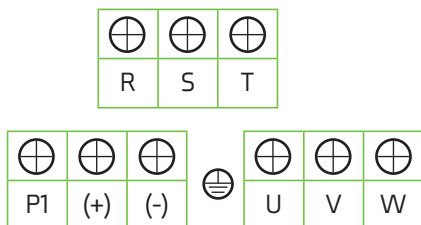

Terminal symbol	Terminal type and description
	Grounding terminal PE
R, S, T	3-phase AC input terminals
(-), (+)	DC bus negative and positive terminals, common DC bus input
P1, (+)	DC reactor reserved terminals, default connected by copper busbar
U, V, W	3-phase AC output terminals

5, NE300-4T1600G/1850PB -F~ NE300-4T8000G/9000PB-F

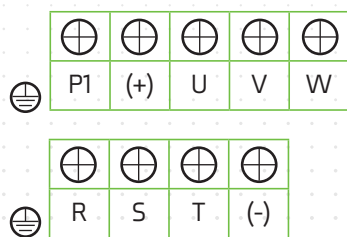

Terminal symbol	Terminal type and description
	Grounding terminal PE
R, S, T	3-phase AC input terminals
(-), (+)	DC bus negative and positive terminals for common DC bus input
P1, (+)	Reserved for DC reactor connecting terminals; Short circuited with copper plate as factory setting
U, V, W	3-phase AC output terminals

NE200 DIMENSIONS & WEIGHTS

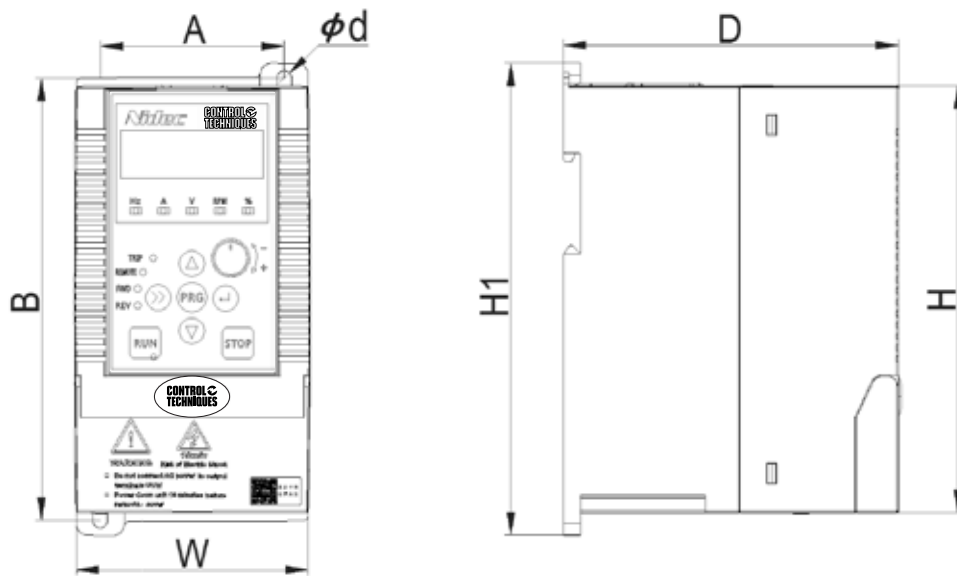

Drive model G: Heavy Duty P: Normal Duty	Order code	Rated output current (A)	Motor power (KW)	H Height (mm)	W Width (mm)	D Depth (mm)	H1 Height (mm)	A (mm)	B (mm)	d (mm)
NE200-2S0004GB	01189010_E	2.5	0.4	150	83	120	166	65	153	5
NE200-2S0007GB	01189011_E	4.5	0.75							
NE200-2S0015GB	01189012_E	7	1.5							
NE200-4T0007G/015PB	01189013_E	2.5/4.0	0.75/1.5							
NE200-4T0015G/0022PB	01189014_E	4.0/6.0	1.5/2.2	200	120	140	215	98	202	5
NE200-4T0022GB-M	01189015_E	6.0	2.2							
NE200-2S0022GB	01189016_E	10	2.2							
NE200-4T0022G/0040PB	01189018_E	6.0/9.0	2.2/4.0	200	120	140	215	98	202	5
NE200-4T0040G/0055PB	01189019_E	9.0/13	4.0/5.5							

NE300 DIMENSIONS & WEIGHTS

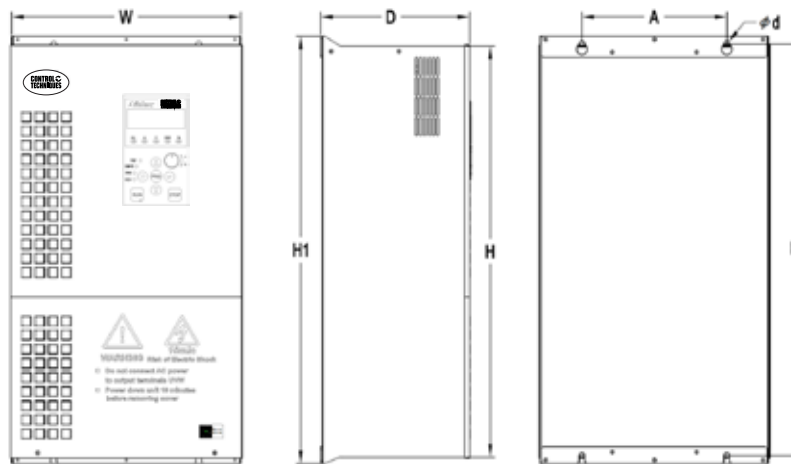

Drive model G: Heavy Duty P: Normal Duty	Rated output current (A)	Motor power (KW)	H Height (mm)	W Width (mm)	D Depth (mm)	H1 Height (mm)	A (mm)	B (mm)	d (mm)
NE300-4T0015G/0022PB	4.0/6.0	1.5/2.2							
NE300-4T0022G/0040PB	6.0/9.0	2.2/4.0	210	133	180	238	108	225	7
NE300-4T0040G/0055PB	9.0/13	4.0/5.5							
NE300-4T0055G/0075PB	13/17	5.5/7.5							
NE300-4T0075G/0110PB	17/25	7.5/11	258	155	180	285	120	270	7
NE300-4T0110G/0150PB	25/32	11/15							
NE300-4T0150G/0185PB	32/37	15/18.5							
NE300-4T0185G/0220PB	37/45	18.5/22	308	192	186	340	150	323	7
NE300-4T0220G/0300PB	45/60	22/30							
NE300-4T0300G/0370P	60/75	30/37	425	270	200	450	200	430	7
NE300-4T0370G/0450P	75/90	37/45							
NE300-4T0450G/0550P	90/110	45/55	535	320	248	560	240	540	9
NE300-4T0550G/0750P	110/150	55/75							
NE300-4T0750G/0900P	150/176	75/90							
NE300-4T0900G/1100P	176/210	90/110	640	380	248	665	240	640	9
NE300-4T1100G/1320P	210/250	110/132							

* Specialized drive and Vector control with PG card (VC) model selection, please consult our company for detail.

NE300 order code and dimension:

Drive model G: Heavy Duty P: Normal Duty	Rated output current (A)	Motor power (KW)	H Height (mm)	W Width (mm)	D Depth (mm)	H1 Height (mm)	A (mm)	B (mm)	d (mm)
NE300-4T1320G/1600P-U	250/300	132/160	710	465	355	750	380	719	11
NE300-4T1320G/1600P-D	250/300	132/160							
NE300-4T1600G/1850P-U	300/340	160/185							
NE300-4T1600G/1850P-D	300/340	160/185							
NE300-4T1850G/2000P-U	340/380	185/200							
NE300-4T1850G/2000P-D	340/380	185/200							
NE300-4T2000G/2200P-U	380/420	200/220	859	550	385	900	440	868	11
NE300-4T2000G/2200P-D	380/420	200/220							
NE300-4T2200G/2500P-U	420/470	220/250							
NE300-4T2200G/2500P-D	420/470	220/250							
NE300-4T2500G/2800P-U	470/540	250/280							
NE300-4T2500G/2800P-D	470/540	250/280							

NE300 series cabinet machine model and dimension:

Drive model G: Heavy Duty P: Normal Duty	Rated output current (A)	Motor power (KW)	Dimensions
NE300-4T1600G/1850P-F	300/340	160/185	
NE300-4T1850G/2000P-F	340/380	185/200	
NE300-4T2000G/2200P-F	380/420	200/220	
NE300-4T2200G/2500P-F	420/470	220/250	

Drive model G: Heavy Duty P: Normal Duty	Rated output current (A)	Motor power (KW)	Dimensions
NE300-4T2500G/2800P-F	470/540	250/280	
NE300-4T2800G/3150P-F	540/600	280/315	
NE300-4T3150G/3550P-F	600/660	315/355	

NE300 series cabinet machine model and dimension:

Drive model G: Heavy Duty P: Normal Duty	Rated output current (A)	Motor power (KW)	Dimensions
NE300-4T3550G/4000P-F	660/730	355/400	
NE300-4T4000G/4500P-F	730/840	400/450	
NE300-4T4500G/5000P-F	840/900	450/500	
NE300-4T5000G/5600P-F	900/950	500/560	

Drive model G: Heavy Duty P: Normal Duty	Rated output current (A)	Motor power (KW)	Dimensions
NE300-4T5600G/6300P-F	950/1160	560/630	
NE300-4T6300G/7100P-F	1160/1300	630/710	
NE300-4T7100G/8000P-F	1300/1460	710/800	
NE300-4T8000G/9000P-F	1460/1640	800/900	

Drive model G: Heavy Duty P: Normal Duty	Rated output current (A)	Motor power (KW)	Dimensions
NE300-4T9000G-F	1640	900	

*-F freestanding drive with DC reactor inbuilt;

*-U upside input downside output type wall mounting structure;

*-D downside input upside output type wall mounting structure.

* Specialized drive and Vector control with PG card model selection, please consult our company for detail.

Product Model description

<p>NE300 -</p> <p style="text-align: center;">⋮</p> <p>4T</p> <p style="text-align: center;">⋮</p> <p>1320</p> <p style="text-align: center;">⋮</p> <p>G</p> <p style="text-align: center;">⋮</p> <p>B</p> <p style="text-align: center;">⋮</p> <p>-</p> <p style="text-align: center;">⋮</p> <p>U</p>	<p>Voltage rating: 2S -- 200V~240V 4T -- 380V~440V</p>	<p>Load type: G -- Heavy duty P -- Normal duty</p>	<p>Structure code: None -- Standard M -- Compact U -- top input-bottom output D -- bottom input—top output F -- cubicle</p>
<p>Product series: NE200 NE300</p>	<p>Power rating: 0004 -- (0.4KW) 0007 -- (0.75KW) 0015 -- (1.5KW) 1320 -- (132KW) 9000 -- (900KW)</p>	<p>Braking unit: None -- No braking unit B -- With braking unit</p>	

Note: Some types of NE200 and NE300 products are dual rated e.g. NE300-4T0185G/0220PB

Keypad

	Order code	Specification	Drive model
LED Keypad	NEF-LED01	Standard	NE200/NE300
LCD Keypad	NEF-LCD01	Optional	NE200/NE300
Keypad holder	NEF-KB01	Optional	NE200/NE300
Keypad cable	NEF-CB0020	2m(Optional)	NE200/NE300
Keypad cable	NEF-CB0030	3m(Optional)	NE200/NE300



NEF-LED01



NEF-LCD01



NEF-KB01

LED keypad display and keypad holder dimensions: (mm)

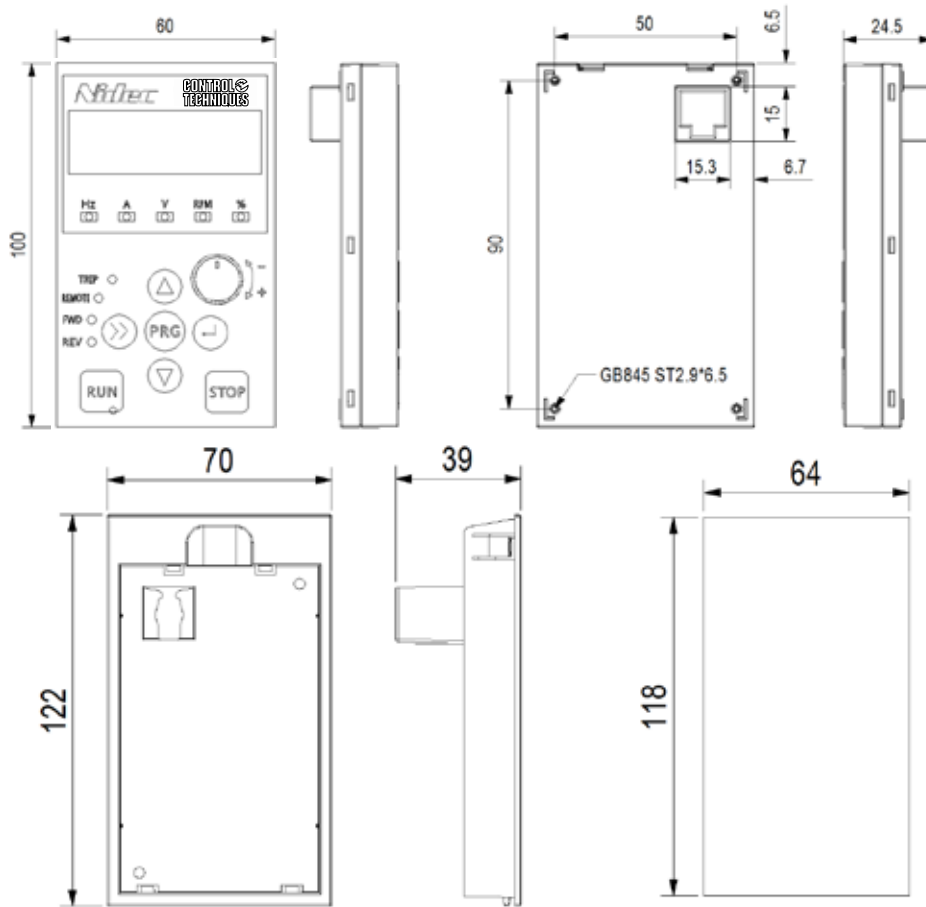

Braking resistor
NE200 braking resistor

Drive model	Braking unit	Braking resistor		Braking torque %	
		Braking resistor	Quantity		
NE200-2S0004GB	Inbuilt as standard	100W	200Ω	1	135
NE200-2S0007GB		200W	150Ω	1	135
NE200-2S0015GB		400W	100Ω	1	125
NE200-2S0022GB		300W	70Ω	1	125
NE200-4T0007G/0015PB		400W	300Ω	1	135
NE200-4T0015G/0022PB		400W	300Ω	1	135
NE200-4T0022GB-M		500W	200Ω	1	135
NE200-4T0022G/0040PB		500W	200Ω	1	135
NE200-4T0040G/0055PB		500W	200Ω	1	135

NE300 braking resistor

Drive model	Braking unit	Braking resistor			Braking torque %
		Braking resistor	Quantity		
NE300-4T0015G/0022PB	Inbuilt as standard	400W	300Ω	1	135
NE300-4T0022G/0040PB		500W	200Ω	1	135
NE300-4T0040G/0055PB		500W	200Ω	1	135
NE300-4T0055G/0075PB		500W	100Ω	1	135
NE300-4T0075G/0110PB		800W	75Ω	1	130
NE300-4T0110G/0150PB		1000W	50Ω	1	135
NE300-4T0150G/0185PB		1500W	40Ω	1	125
NE300-4T0185G/0220PB		4000W	30Ω	1	125
NE300-4T0220G/0300PB		4000W	30Ω	1	125
NE300-4T0300G/0370P		6000W	20Ω	1	125
NE300-4T0370G/0450P		9000W	16Ω	1	125
NE300-4T0450G/0550P		9000W	13.6Ω	1	125
NE300-4T0550G/0750P		6000W	20Ω	2	135
NE300-4T0750G/0900P		9000W	13.6Ω	2	145
NE300-4T0900G/1100P	6000W	20Ω	3	130	
NE300-4T1100G/1320P	6000W	20Ω	3	130	
NE300-4T1320G/1600P-U	6000W	20Ω	4	130	
NE300-4T1320G/1600P-D	6000W	20Ω	4	130	
NE300-4T1600G/1850P-U	9000W	13.6Ω	4	130	
NE300-4T1600G/1850P-D	9000W	13.6Ω	4	130	
NE300-4T1600G/1850P-F	9000W	13.6Ω	4	130	

* Multi braking resistors parallel connection. E.g. NE300-4T0550G/0750P recommended to select 2 of 6000W, 20Ω resistors parallel connection, compound braking resistor is 12000W, 10Ω.

NE300 braking resistor

Drive model	Braking unit	Braking resistor		Braking torque %	
		Braking resistor	Quantity		
NE300-4T1850G/2000P-U	Need external	9000W	13.6Ω	4	130
NE300-4T1850G/2000P-D		9000W	13.6Ω	4	130
NE300-4T1850G/2000P-F		9000W	13.6Ω	4	130
NE300-4T2000G/2200P-U		9000W	13.6Ω	5	130
NE300-4T2000G/2200P-D		9000W	13.6Ω	5	130
NE300-4T2000G/2200P-F		9000W	13.6Ω	5	130
NE300-4T2200G/2500P-U		9000W	13.6Ω	5	130
NE300-4T2200G/2500P-D		9000W	13.6Ω	5	130
NE300-4T2200G/2500P-F		9000W	13.6Ω	5	130
NE300-4T2500G/2800P-U		9000W	13.6Ω	5	130
NE300-4T2500G/2800P-D		9000W	13.6Ω	5	130
NE300-4T2500G/2800P-F		9000W	13.6Ω	5	130
NE300-4T2800G/3150P-F		9000W	13.6Ω	6	130
NE300-4T3150G/3550P-F		9000W	13.6Ω	6	130
NE300-4T3550G/4000P-F		40000W	3Ω	2	130
NE300-4T4000G/4500P-F		40000W	3Ω	2	130
NE300-4T4500G/5000P-F		60000W	2Ω	2	130
NE300-4T5000G/5600P-F		60000W	2Ω	2	130
NE300-4T5600G/6300P-F		60000W	2Ω	2	130
NE300-4T6300G/7100P-F		60000W	2Ω	3	130
NE300-4T7100G/8000P-F		60000W	2Ω	3	130
NE300-4T8000G/9000P-F		80000W	2Ω	3	130
NE300-4T9000G-F		80000W	2Ω	3	130

* Multi braking resistors parallel connection. E.g. NE300-4T0550G/0750P recommended to select 2 of 6000W, 20Ω resistors parallel connection, compound braking resistor is 12000W, 10Ω.

Input/output reactor

DC input reactor parameters

Drive model	Drive power(KW)	DC reactor model	Current(A)	Inductance(mH)	Insulation level
NE300-4T0300G/0370P	30	NE-DCL-0065-AL/4	65	0.8	F
NE300-4T0370G/0450P	37	NE-DCL-0078-AL/4	78	0.7	F
NE300-4T0450G/0550P	45	NE-DCL-0095-AL/4	95	0.54	F
NE300-4T0550G/0750P	55	NE-DCL-0115-AL/4	120	0.45	F
NE300-4T0750G/0900P	75	NE-DCL-0160-AL/4	160	0.36	F
NE300-4T0900G/1100P	90	NE-DCL-0180-AL/4	180	0.33	F
NE300-4T1100G/1320P	110	NE-DCL-0250-AB/4	250	0.26	F
	132		340	0.26	F
	160			0.17	F
	185			0.09	F
	200			0.06	F
	220			0.06	F
	250			0.05	F

3-phase AC input reactor parameter

Drive model	Drive power(KW)	Filter model	Reactor model	Current(A)	Voltage drop (%)	Inductance(mH)	Insulation level
	1.5			5	2	2.8	F
NE200-4T0022G/0040PB	2.2	NE-EFI-0010/4-T	NE-ACL-0007-CL/4-2	7	2	2	F
NE200-4T0040G/0055PB	3.7	NE-EFI-0015/4-T	NE-ACL-0010-CL/4-2	10	2	1.4	F
NE300-4T0055G/0075PB	5.5	NE-EFI-0016/4-T	NE-ACL-0015-AL/4-2	15	2	0.94	F
NE300-4T0075G/0110PB	7.5	NE-EFI-0020/4-T	NE-ACL-0020-AL/4-2	20	2	0.7	F
NE300-4T0110G/0150PB	11	NE-EFI-0030/4-T	NE-ACL-0030-AL/4-2	30	2	0.47	F
NE300-4T0150G/0185PB	15	NE-EFI-0045/4-T	NE-ACL-0040-AL/4-2	40	2	0.36	F
NE300-4T0185G/0220PB	18.5	NE-EFI-0050/4-T	NE-ACL-0050-AL/4-2	50	2	0.28	F
NE300-4T0220G/0300PB	22	NE-EFI-0060/4-T	NE-ACL-0060-AL/4-2	60	2	0.24	F
NE300-4T0300G/0370P	30	NE-EFI-0080/4-T	NE-ACL-0080-AL/4-2	80	2	0.18	F
NE300-4T0370G/0450P	37		NE-ACL-0090-AL/4-2	90	2	0.156	F
NE300-4T0450G/0550P	45	NE-EFI-0100/4-T	NE-ACL-0120-AL/4-2	120	2	0.117	F
NE300-4T0550G/0750P	55	NE-EFI-0120/4-T	NE-ACL-0150-AL/4-2	150	2	0.094	F
NE300-4T0750G/0900P	75	NE-EFI-0150/4-T	NE-ACL-0200-AL/4-2	200	2	0.07	F
NE300-4T0900G/1100P	90	NE-EFI-0200/4-T	NE-ACL-0240-AB/4-2	240	2	0.058	F
NE300-4T1100G/1320P	110	NE-EFI-0300/4-C	NE-ACL-0250-AB/4-2	250	2	0.056	F
	132			290	2	0.048	F
	160			330	2	0.042	F
	185			390	2	0.036	F
	200			490	2	0.028	F
	220			490	2	0.028	F
	250			530	2	0.026	F
	280			600	2	0.024	F
	315			660	2	0.022	F
	355			800	2	0.018	F
	400			1000	2	0.014	F
	450			1130	2	0.012	F
	500			1250	2	0.0117	F

3-phase AC output reactor parameter

Drive model	Drive power(KW)	Filter model	Reactor model	Current(A)	Voltage drop (%)	Inductance(mH)	Insulation level
	1.5			5	1	1.4	F
NE200-4T0022G/0040PB	2.2	NE-EFO-0010/4-T	NE-OCL-0007-CL/4-1	7	1	1	F
NE200-4T0040G/0055PB	4	NE-EFO-0015/4-T	NE-OCL-0010-CL/4-1	10	1	0.7	F
NE300-4T0055G/0075PB	5.5	NE-EFO-0016/4-T	NE-OCL-0015-AL/4-1	15	1	0.47	F
NE300-4T0075G/0110PB	7.5	NE-EFO-0020/4-T	NE-OCL-0020-AL/4-1	20	1	0.35	F
NE300-4T0110G/0150PB	11	NE-EFO-0030/4-T	NE-OCL-0030-AL/4-1	30	1	0.23	F
NE300-4T0150G/0185PB	15	NE-EFO-0045/4-T	NE-OCL-0040-AL/4-1	40	1	0.18	F
NE300-4T0185G/0220PB	18.5	NE-EFO-0050/4-T	NE-OCL-0050-AL/4-1	50	1	0.14	F
NE300-4T0220G/0300PB	22	NE-EFO-0060/4-T	NE-OCL-0060-AL/4-1	60	1	0.12	F
NE300-4T0300G/0370P	30	NE-EFO-0080/4-T	NE-OCL-0080-AL/4-1	80	1	0.087	F
NE300-4T0300G/0370P	37		NE-OCL-0090-AL/4-1	90	1	0.078	F
NE300-4T0450G/0550P	45	NE-EFO-0100/4-T	NE-OCL-0120-AL/4-1	120	1	0.058	F
NE300-4T0550G/0750P	55	NE-EFO-0120/4-T	NE-OCL-0150-AL/4-1	150	1	0.047	F
NE300-4T0750G/0900P	75	NE-EFO-0150/4-T	NE-OCL-0200-AL/4-1	200	1	0.035	F
NE300-4T0900G/1100P	90	NE-EFO-0200/4-T	NE-OCL-0240-AB/4-1	240	1	0.029	F
NE300-4T1100G/1320P	110	NE-EFO-0300/4-C	NE-OCL-0250-AB/4-1	250	1	0.028	F
	132			290	1	0.024	F
	160			330	1	0.021	F
	185			390	1	0.018	F
	200			490	1	0.014	F
	220			490	1	0.014	F
	250			530	1	0.013	F
	280			600	1	0.012	F
	315			660	1	0.011	F
	355			800	1	0.009	F
	400			1000	1	0.007	F
	450			1130	1	0.006	F
	500			1250	1	0.0055	F

NE300 Options

Optional card	Order code	Terminal	Description	Drive model	
I/O extension card	NE30-I/O Lite	X6	Multi-function input 6 (to PLC)	NE300 whole series	
		X7	Multi-function input 7 (to PLC)		
		X8	Multi-function input 8 (to PLC)		
		Y2	Multi-function output Y2 (to COM)		
		BRA/BRB/BRC	Relay output 2		
		PLC	PLC common end (to PLC)		
		A02	Analog output 2 (0 ~ 10V, 0/4 ~ 20mA selectable)		
		GND	Analog output common end		
	NE30-I/O Relay	BRA/BRB/BRC	Relay output 2		
		A02	Analog output 2 (0 ~ 10V, 0/4 ~ 20mA selectable)		NE300 whole series
		GND	Analog output common		
	Injection molding machine extension card	NE30-ZS01	+A1		0-1A current input
-A1			0-1A current output		
+A2			0-1A/2A current input		
-A2			0-1A/2A current output		
X6			Multi-function input 6 (to COM)		
COM			Multi-function input common		
+/- 10V extension card	NE30-AN01	485+	485 differential signal positive	NE300 whole series	
		485-	485 differential signal negative		
		-10V	Provide -10V to external (to GND)		
		A13	+/- 10V analog input (to GND)		
		GND	Analog output common		
Speed tracking extension card	NE30-SP01	U	Connect to drive U-phase output	NE300-4T0015G/0022PB ~ NE300-4T0150G/0185PB	
		W	Connect to drive W-phase output		
CC-Link Communication card	NEF - CCLink	DA	DA Signal	NE300 whole series	
		DB	DB Signal		
		DG	Signal Ground		
		SD	Shield ground		
		FG	Protected area		
Profinet Communication card	NEF - Profinet	RJ45	Two network interfaces	NE300 whole series	
Profibus DP	NEF - Profibus	RxD/TxD-P	Positive Data transfer	NE300 whole series	
		RxD/TxD-N	Negative Data transfer		
		+5V	Power supply		
		0V	Ground		
		Shield	Shield		
Modbus TCP	NEF - TCP	RJ45	Two gateways	NE300 whole series	

NE Series Expansion Card



Coming soon: EtherCAT EtherNet/IP

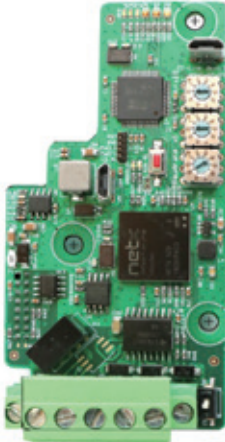
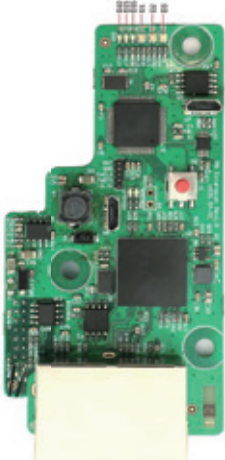

*NE200 does not support any optional cards

THINK DRIVES, THINK CONTROL TECHNIQUES.

1K+

OEM Customers

5M+

Installed Drives

1.4K+

Employees

70

Countries



CONTROL TECHNIQUES

THE GLOBAL DRIVE

SPECIALISTS SINCE 1973

Control Techniques has been designing and manufacturing the best variable speed drives in the world since 1973.

Our customers reward our commitment to building drives that outperform the market. They trust us to deliver on time every time with our trademark outstanding service.

More than 45 years later, we're still in pursuit of the best motor control, reliability and energy efficiency you can build into a drive. That's what we promise to deliver, today and always.



Outstanding Performance

Applying our more than 45 years' engineering experience to everything we do means we outstrip the competition time and again.



Tried and Trusted

Millions of people around the world trust us knowing we're committed to unrivalled design and top build quality.



Total Flexibility

Our drives are built with open design architecture. They integrate with all primary communication protocols providing all the flexibility you could want.



Embedded Intelligence

Combining precision motor control with the highest embedded intelligence means ultimate productivity and efficiency for your machinery.



Global Reach, Local Support

Our dedicated Application Engineers in 70 countries are obsessed with ever-better drive design and technology. **That's what gives us the edge.**



CONTROL TECHNIQUES IS YOUR GLOBAL DRIVES SPECIALIST.

With operations in over 70 countries, we're open for business wherever you are in the world.

For more information, or to find your local drive centre representatives, visit:

www.controltechniques.com

Connect with us



©2020 Nidec Control Techniques Limited. The information contained in this brochure is for guidance only and does not form part of any contract. The accuracy cannot be guaranteed as Nidec Control Techniques Ltd have an ongoing process of development and reserve the right to change the specification of their products without notice.

Nidec Control Techniques Limited. Registered Office: The Gro, Newtown, Powys SY16 3BE.

Registered in England and Wales. Company Reg. No. 01236886.

